

PART NAME

NEMA 4 ENCLOSURE

PART No.

AN-1302, AN-1302-G, AN-2802 & AN-2802-B

REV. DATE

12-6-07

MATERIAL: ALUMINUM ALLOY #ADC-12

FINISH: NATURAL (NO SUFFIX)

GRAY (SUFFIX -G)

SMOOTH BLACK (SUFFIX -B)

NOTES:

- 1) FOUR (4) M4 x 20mm (0.787") LG. SCREWS SUPPLIED FOR ASSEMBLY OF COVER TO BODY.
- 2) ALL HOLE DIAMETERS HAVE ±0.005 TOLERANCE ALL OTHER DIMENSIONS HAVE ±0.015 TOLERANCE

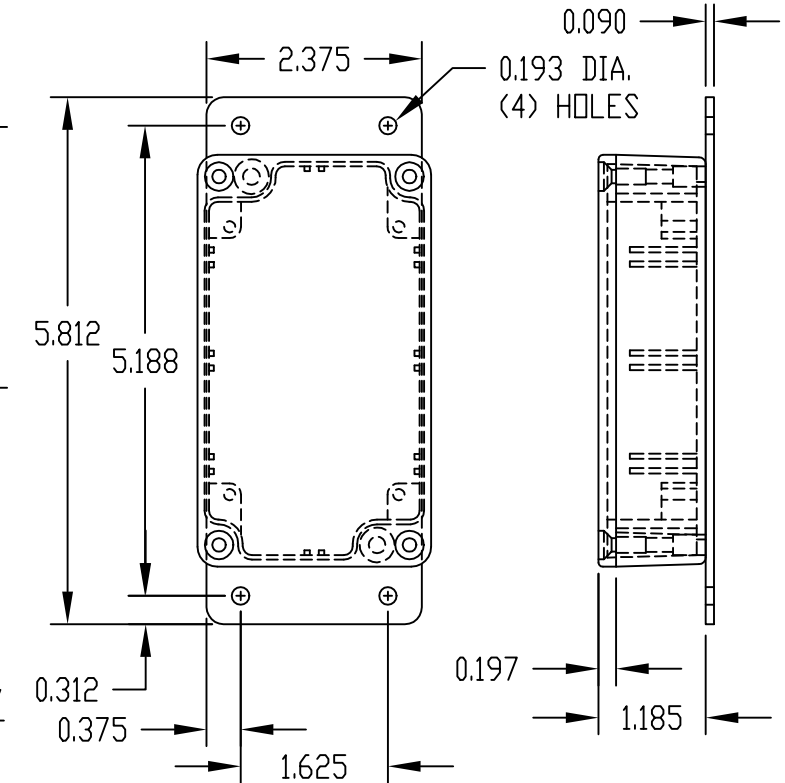
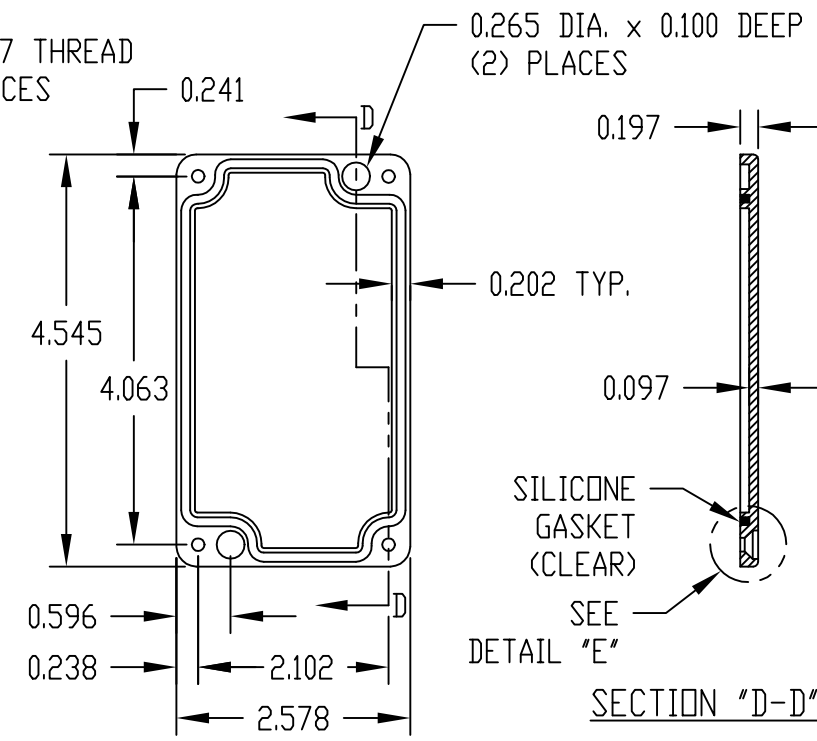
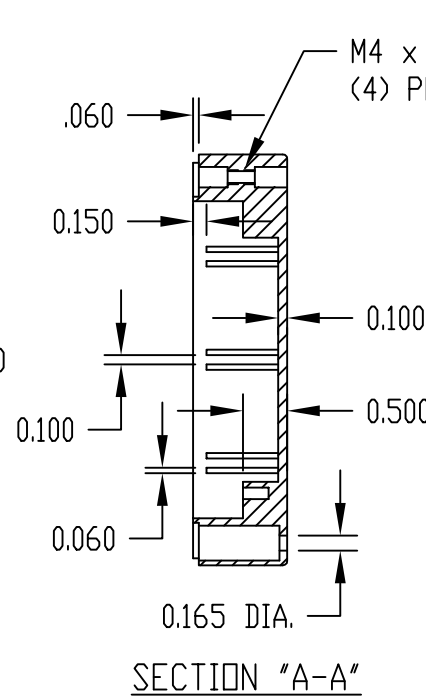
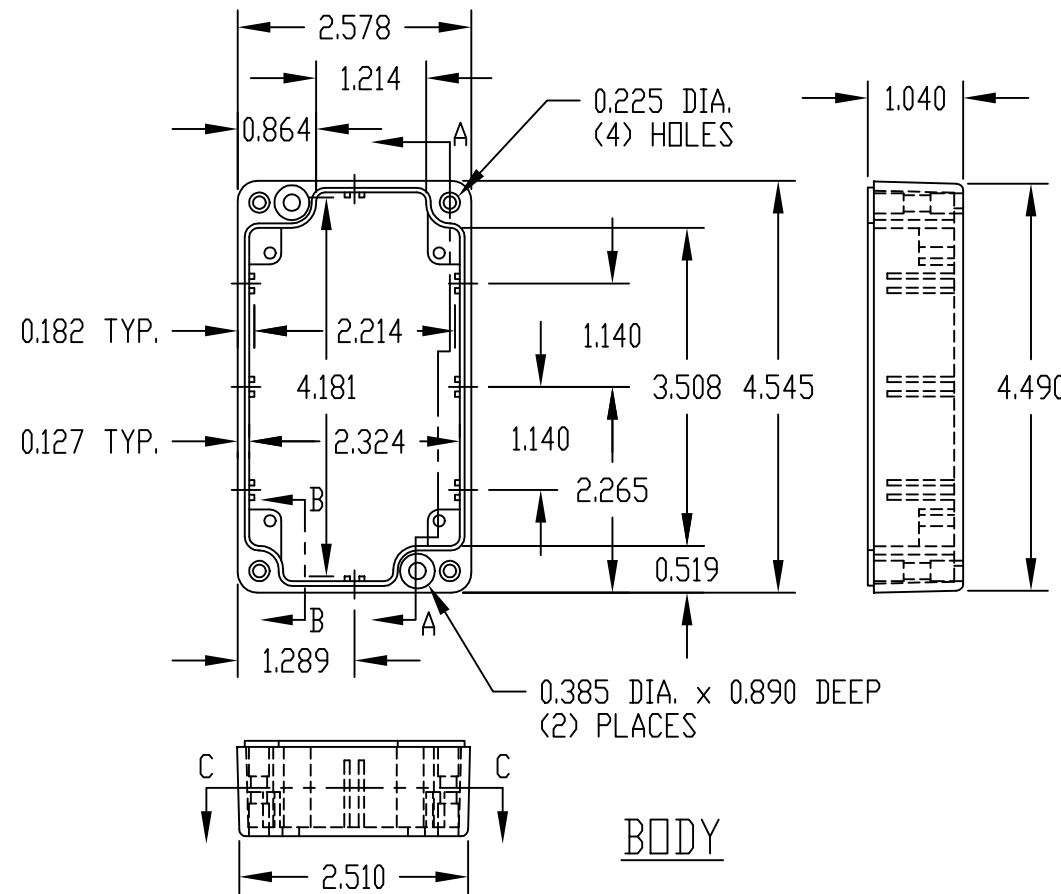
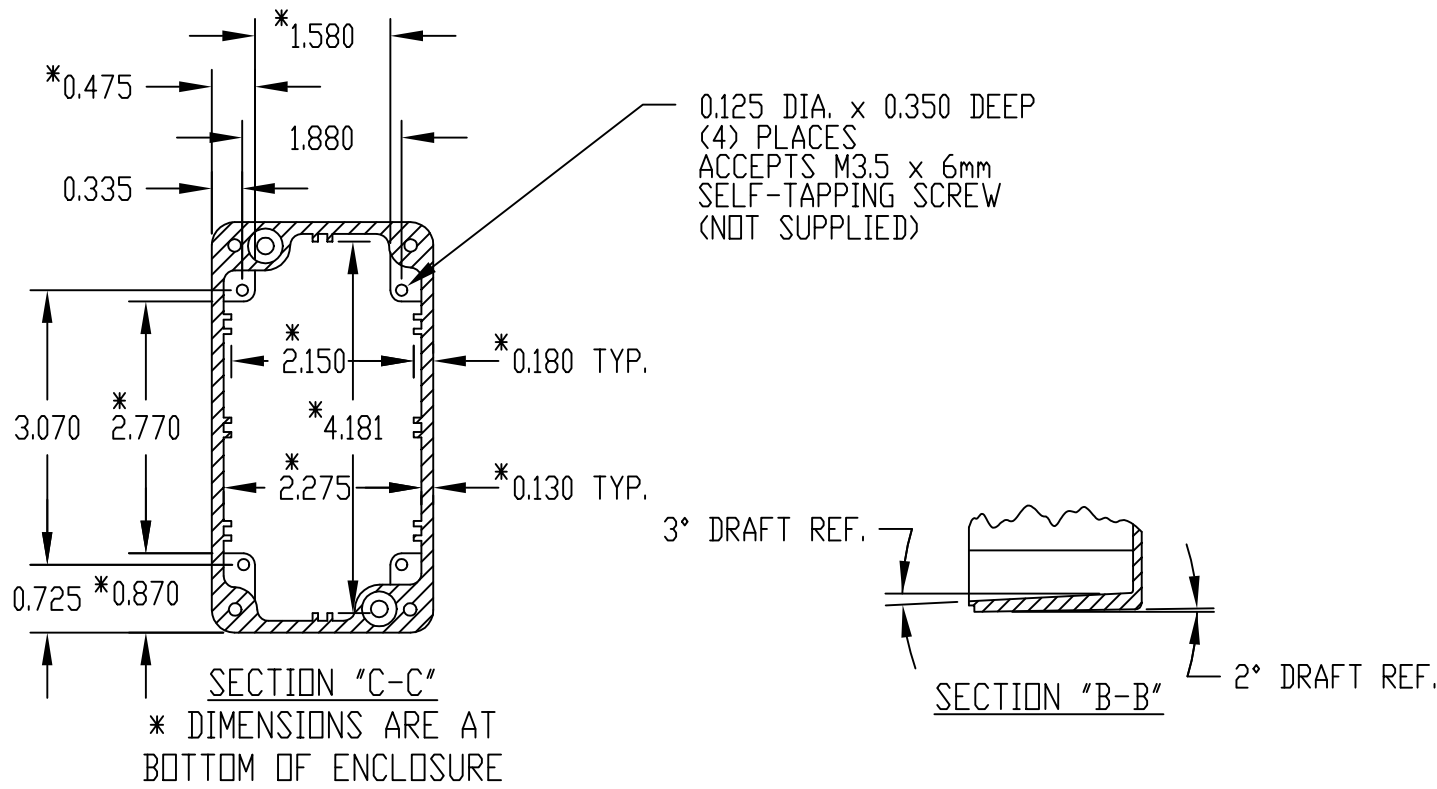

PART NO. AN-2802 & AN-2802-B ARE SUPPLIED WITH A WELDED ON MOUNTING BRACKET ONLY.